

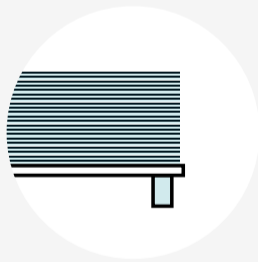

Fibo Fire Rated Panel

INSTALLATION INSTRUCTION



STORAGE

Keep the panels stored dry and flat in their packaging until installation.



VISUAL INSPECTION

Check for product flaws before installation. Colour differences may occur on natural products.



TERMS OF CONDITION

Panels must be kept at minimum 3 days (72 h) in these conditions before installation. Humidity: 30-60%. Temperature: 15-30 C°.

RECOMMENDED TOOLS

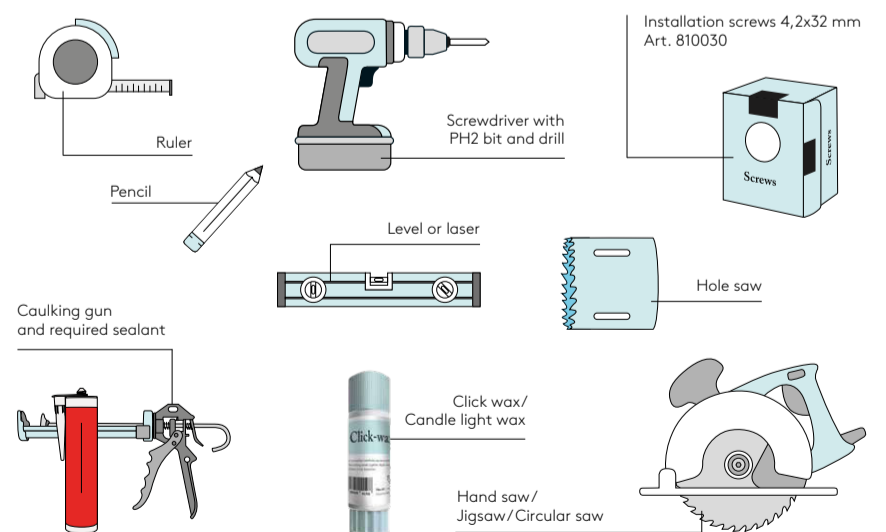

* In wetroom, always use Fireguard 564 sealant according to Sintef Technical Approval.



SELECT PREFERRED BACK WALL OPTION

Make sure that the back wall is level and accordingly your markets national building regulations. Extra support in backwall must be used if heavy objects such as cabinets, toilets, support handles or similar is to be installed. Flatness tolerance: Maximum flatness deviation of +/-2 mm /2 meters. There is no need for extra membrane behind the wall panels.

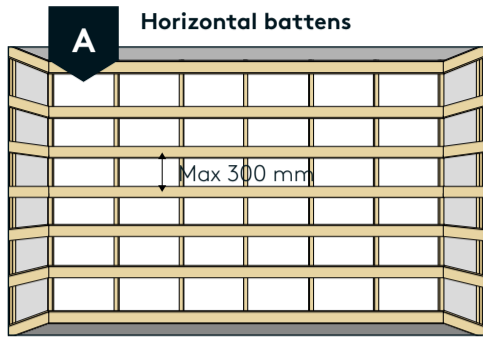

For battens use min. 21 x 98 mm rough wood or 12 x 200 mm plywood. Fasten the panel with two screws into each batten.

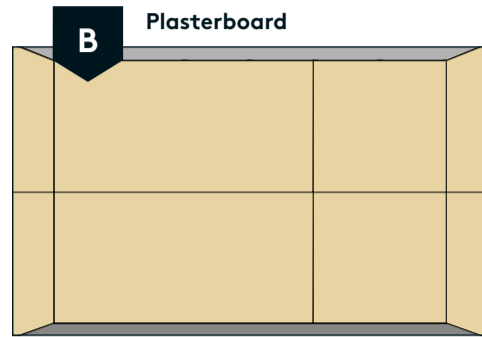

Fit plasterboards horizontally due to the seams. Min. 12.5 mm thickness. Add noggings at cc 800mm, or use two layers of plasterboard. Screw the panels through plasterboards and into the studs behind.

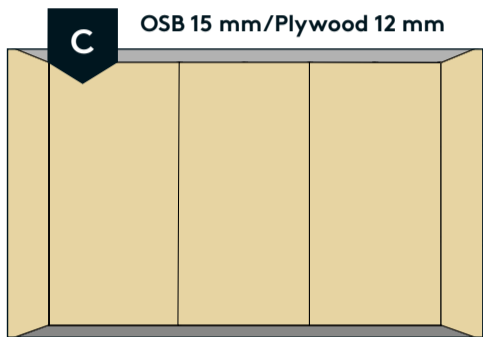

May be installed horizontally or vertically. No need for noggings behind the sheets. Screw the panels directly onto the sheets.

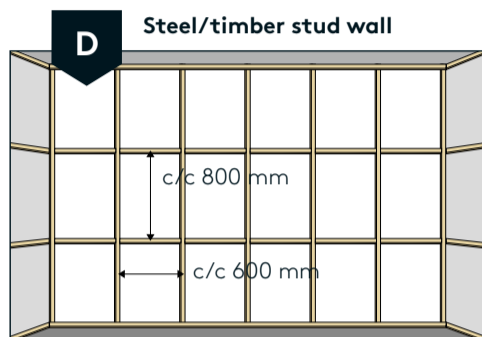

Timber or steel studs with recommended spacing as shown in the illustration.

HOW TO SEAL THE CLICK LOCK

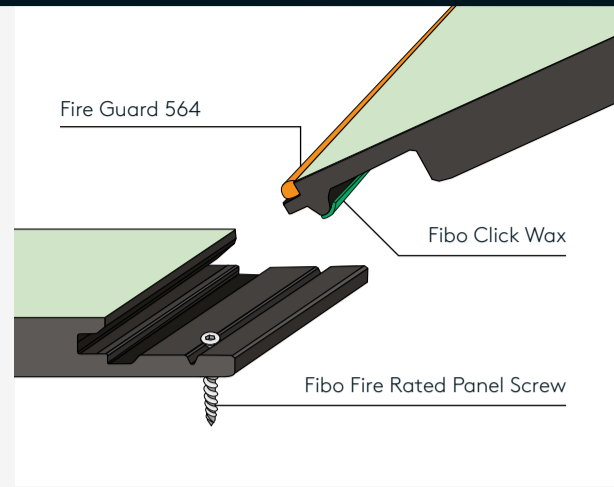

ESSENTIAL FOR AN OPTIMAL RESULT

Apply Fire Guard 564 sealant in the click lock as shown to ensure a watertight result.

Apply Fibo Click-Wax behind the click-lock as instructed to ease the installation when clicking the panels together.

TRANSITION TO FLOOR MEMBRANE

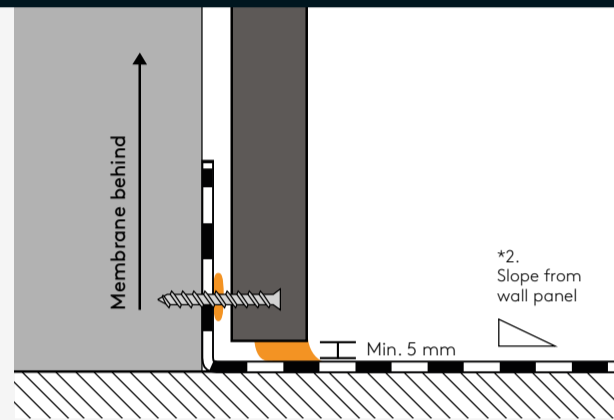

REQUIREMENTS

The floor must be level.

The floor must obtain a slope from the wall towards the drainage point.

Sealant must be applied between base profile and flooring to maintain sanitary conditions.

PAY CLOSE ATTENTION TO THE FITTING INSTRUCTIONS FOR THE BEST RESULTS

Note: We recommend pre-drilling holes for the screws in the screw-lip (4.2-4.5 mm drill bit) for secure fastening. In wet rooms always use Fireguard 564 according to Sintef Technical Approval. Sealant is required behind the panels.

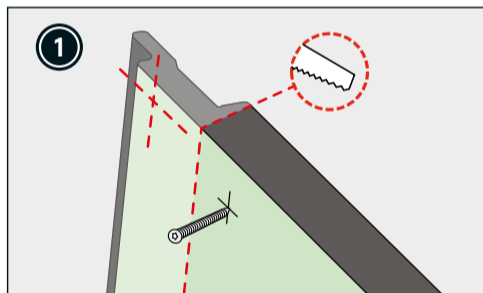

Remove the click lock on the left-hand side of the first panel. The black cross shows the location of the screw.

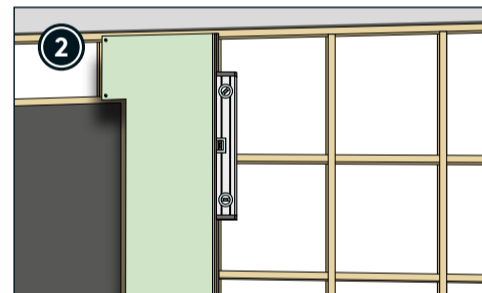

Start the installation above door. Ensure that the first panel is level.

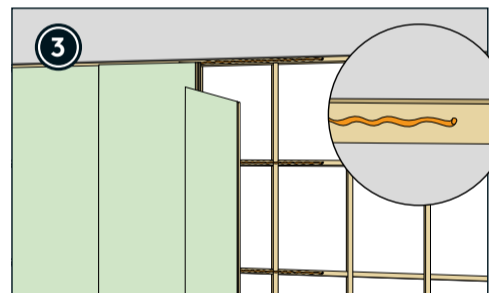

For wet rooms sealant is required behind the panels. Apply onto horizontal strips as shown.

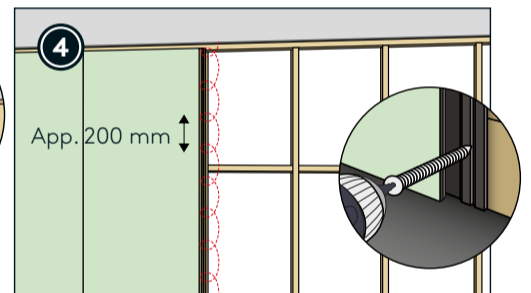

Fasten with screws at a distance of approx. 200 mm. The recommended is Fibo Screws for Fire Rated Panel (art. no. 810032).

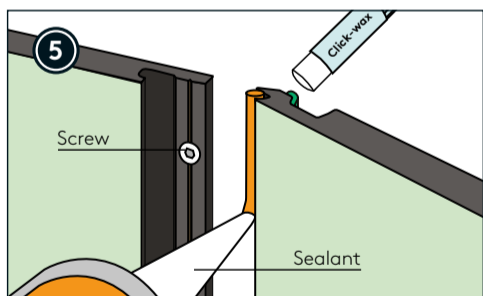

Use sealant on the click-lock to reduce the risk of cracking after drying. Use Fibo Click-wax behind the click (ref. image no. 12)

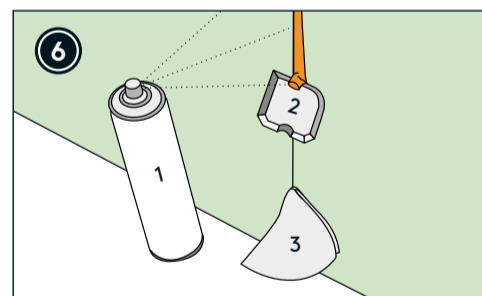

You can use Fibo accessories to remove excess sealant.

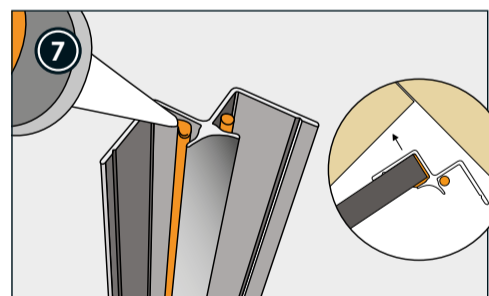

Apply sealant to the internal corner profile as shown above, to reduce noise and improve its grip. Slide into place and fasten corner profile with screw into back wall.

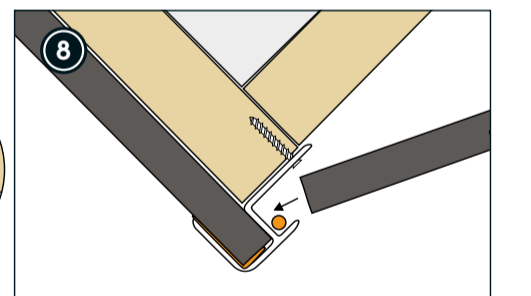

Apply sealant to the external corner profile to reduce noise and improve its grip. Screw the profile to the back wall as shown above.

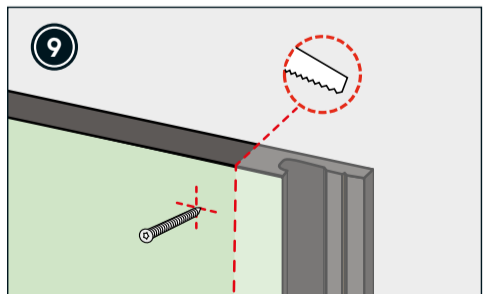

Cut to size and remove the click lock from the last panel.

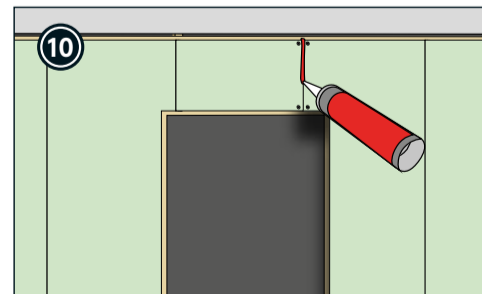

Apply fire-resistant sealant according to EN 1366-Part 4 in the panel joint above the door.

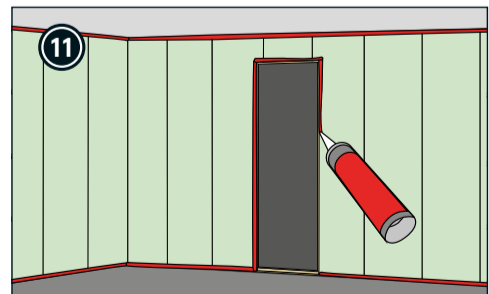

All transitions/gaps needs to be sealed with fire-resistant sealant according to EN 1366-Part 4.

OPTIMAL FOR USE IN WET ZONES AND OTHER DEMANDING AREAS



WALLS BUILT FOR LIFE

info@fibosystem.com